

- | | |
|------------------------------|----------------------------|
| 1 Antenne | 8 Optionsplatz 3 |
| 2 Senderakkuspannungsanzeige | 9 EIN/AUS-Schalter |
| 3 Optionsplatz 1 | 10 Verschlussschieber |
| 4 Steuerknüppel Funk. 3+4 | 11 Trimmung Funktion 1 |
| 5 Trimmung Funktion 3 | 12 Trimmung Funktion 2 |
| 6 Trimmung Funktion 4 | 13 Steuerknüppel Funk. 1+2 |
| 7 Einbauplatz Schieberegler | 14 Optionsplatz 2 |

1: Bedienungselemente des Senders

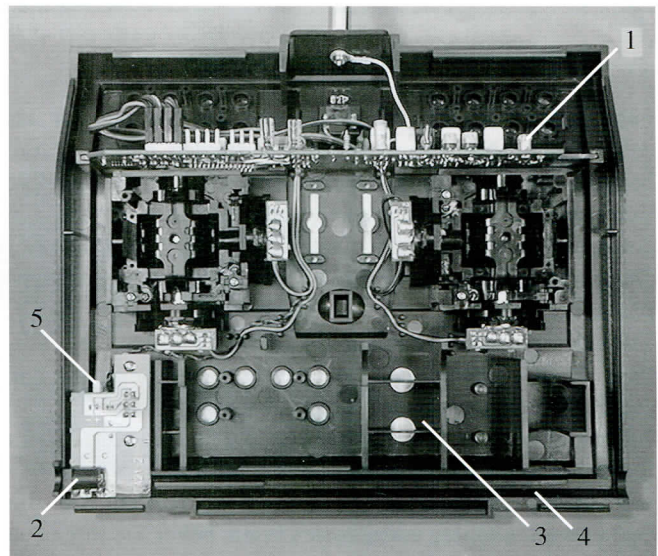

- | | |
|-----------------------------|---------------------------|
| 1 Senderhauptplatine | 4 Antennenfach |
| 2 Ladebuchse | 5 Stecker für Senderakkus |
| 3 Akkufach und Optionsplatz | |

3: Innenansicht des Senders

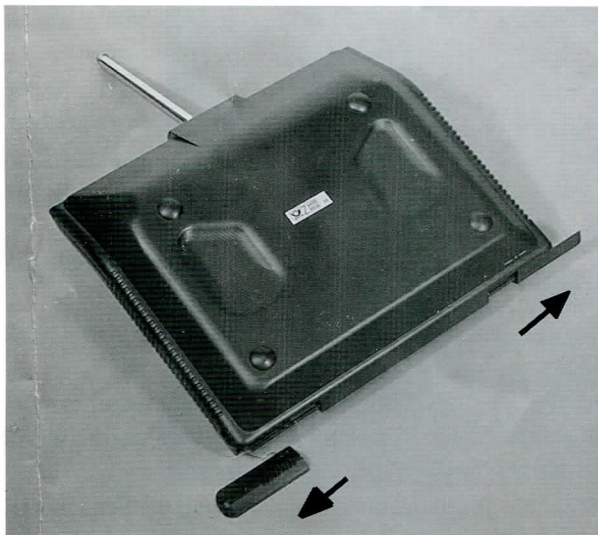

2: Abnehmen der Senderrückwand



4: Ladevorgang

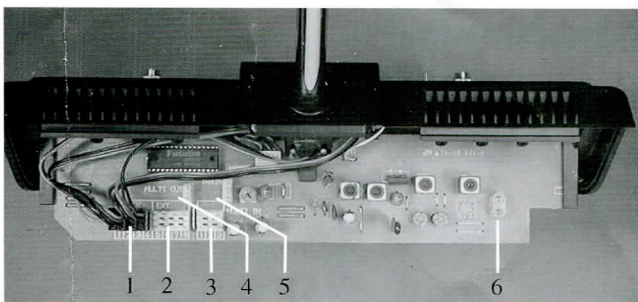

- | | |
|--|-------------------------------|
| 1 Stiftleiste für Steuerknüppel / -geber 1-4 | 5..Lehrer-Schüler Stiftleiste |
| 2 Stiftleiste für Steuerknüppel / -geber 5-8 | 6 Quarzsockel |
| 3 Multi-In Stiftleiste | |
| 4 Multi-Out Stiftleiste | |

5: Senderhauptplatine

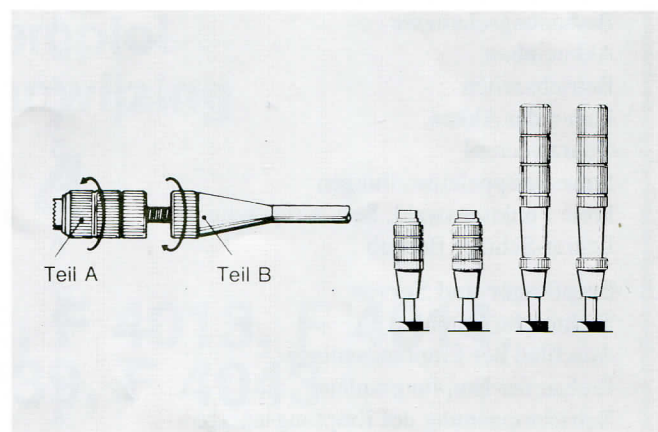

6: Einstellbare Steuerknüppel

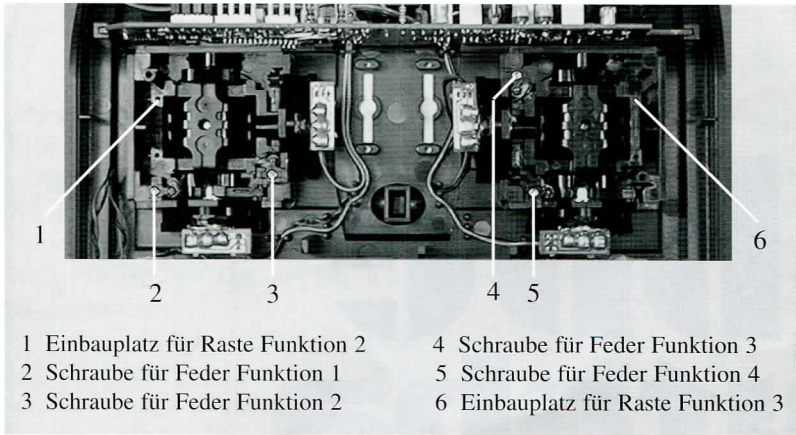

7: Federkraft der Steuerknüppel, Ein- bzw. Umbau der Drosselratsche



8: Lehrer - Schüler Betrieb

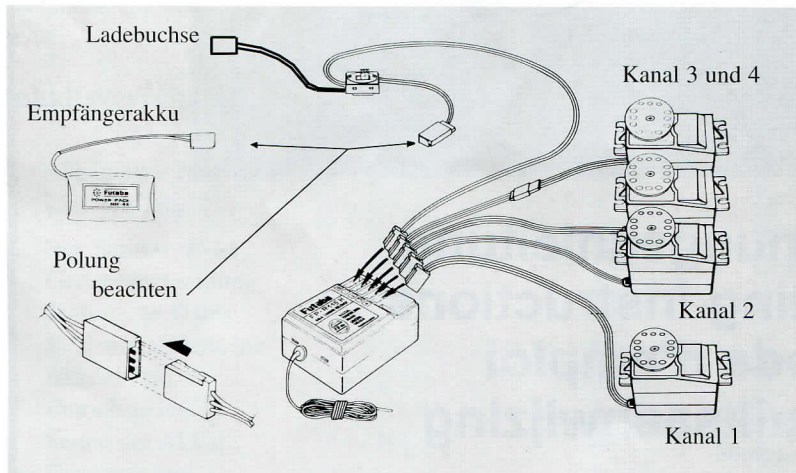

9: Anschluß der Empfangsanlage

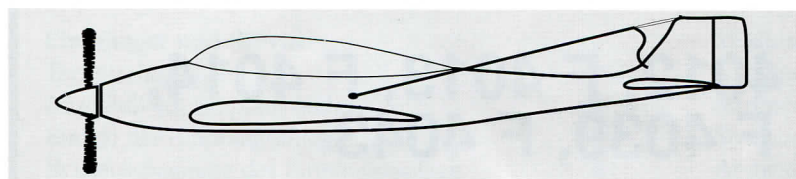

10: Befestigung der Empfangsantenne

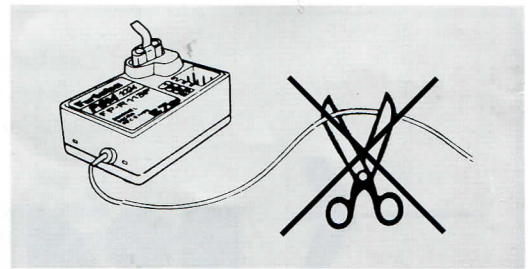

11. Kürzung der Empfangsantenne

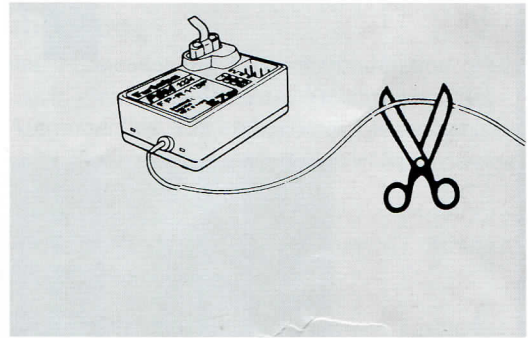

12: Verlegung der Antenne auf einer Platte

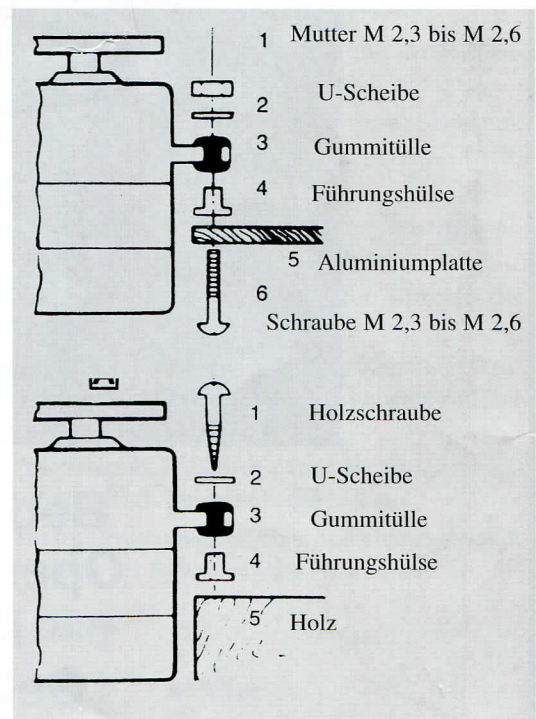

13: Servomontage

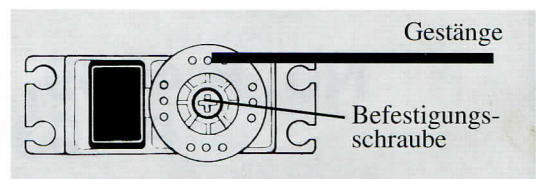

14: Servoneutral-Position

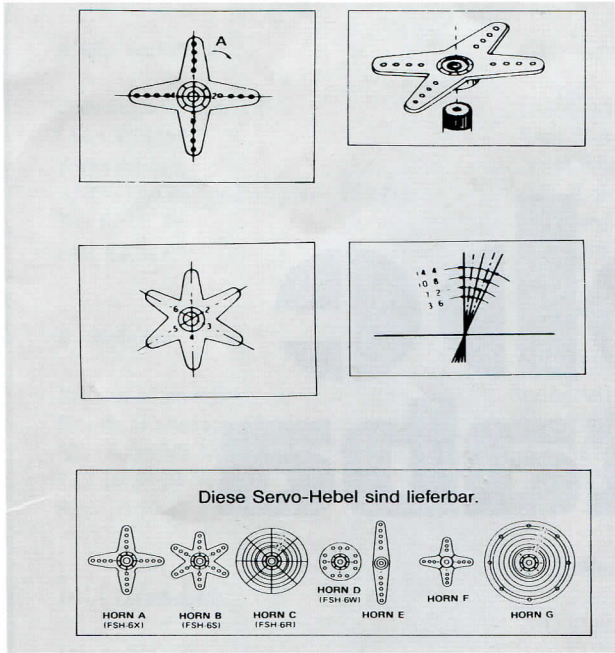

15: Segmenteinteilung und lieferbare Servohebel

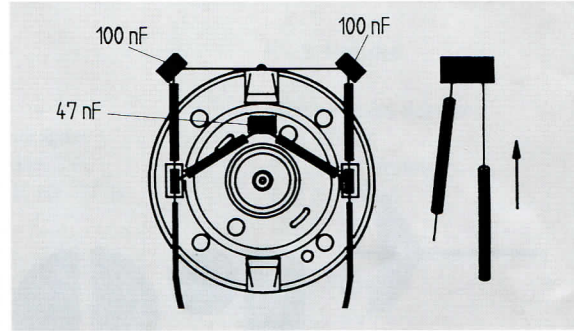

16: Entstörung eines Elektromotors

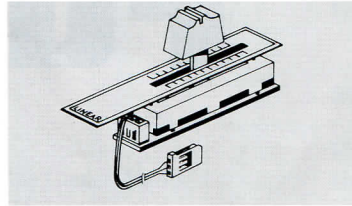

17: Proportional-Kanal linear

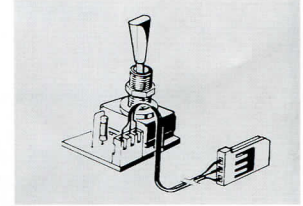

18: Schalt-Kanal 3-Positionen

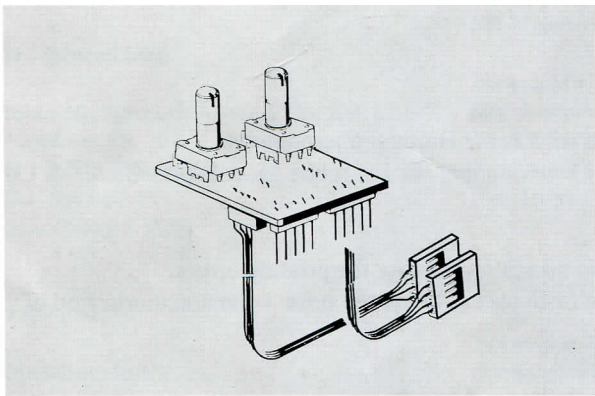

19: Dual Rate-Modul

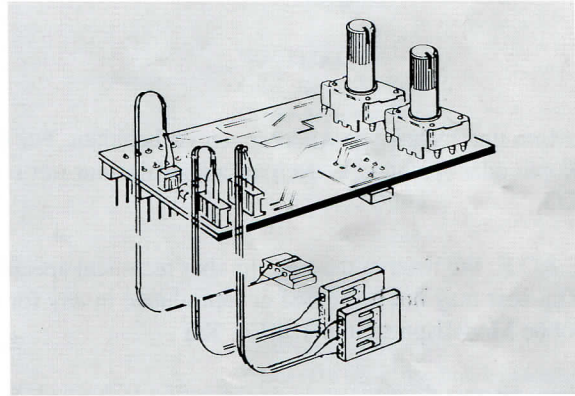

20: Mini-Option

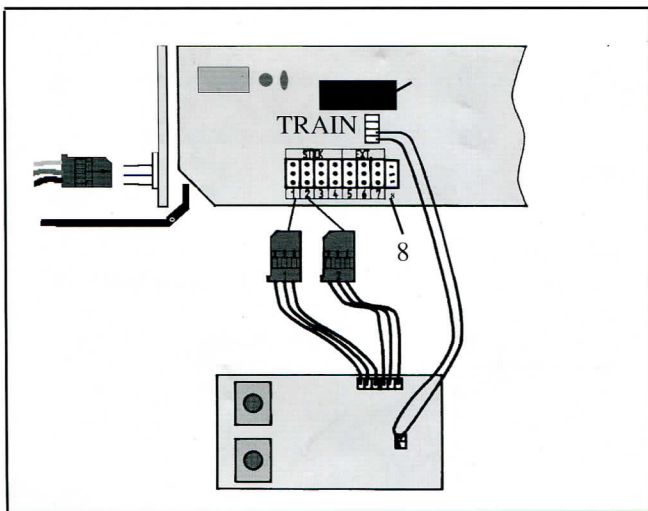

21: Anschluß der Mini-Option

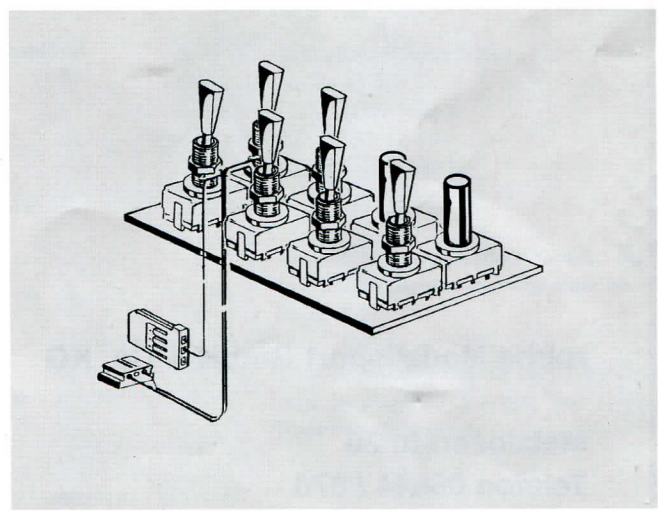

22: Multi-Switch Prop 12+2 Modul

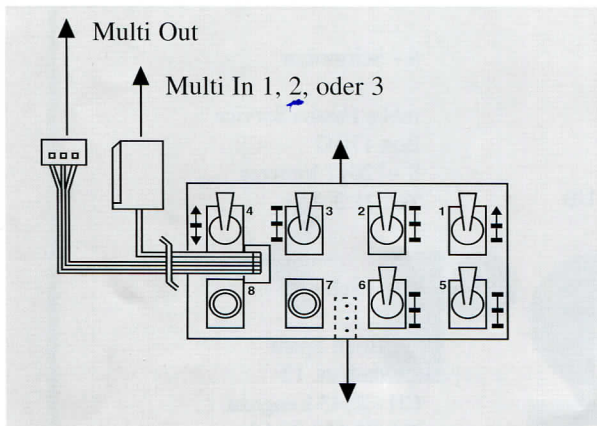

23: Anschluß des Multi-Switch Prop 12+2 Moduls

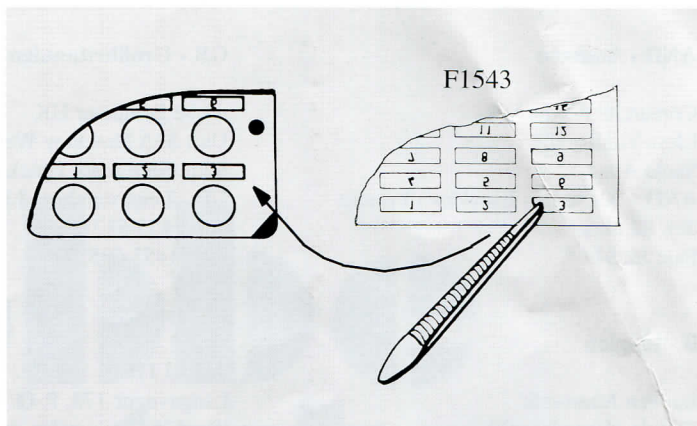

24: Anbringen von Markierungsetiketten

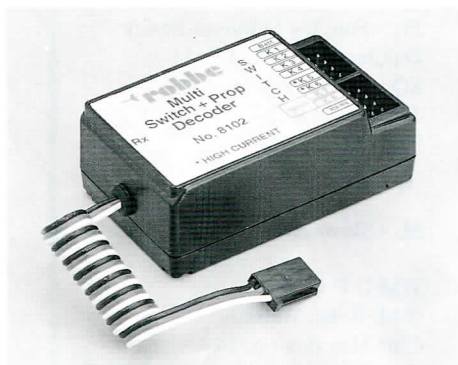

25. Multi-Switch Prop 12+2 Decoder

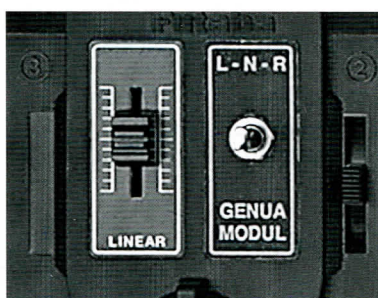

26: Genua Modul

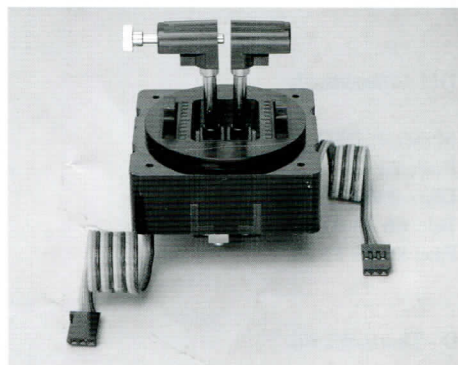

27: Navy-Twin Stick



28: F-14 Navy Set

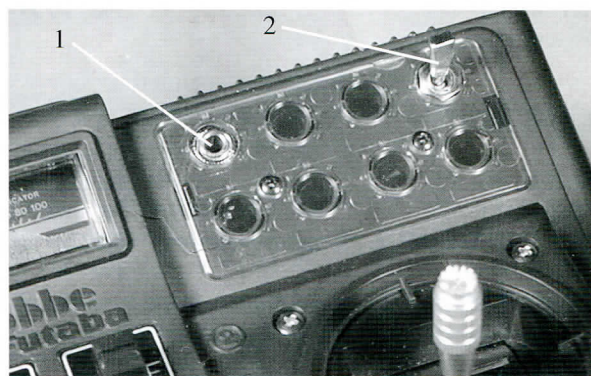

1. Anschlußbuchse
2. Lehrer-Schüler-Umschalter

30: Trainer - Modul 4



29: Multi-Switch Abdeckung F1562

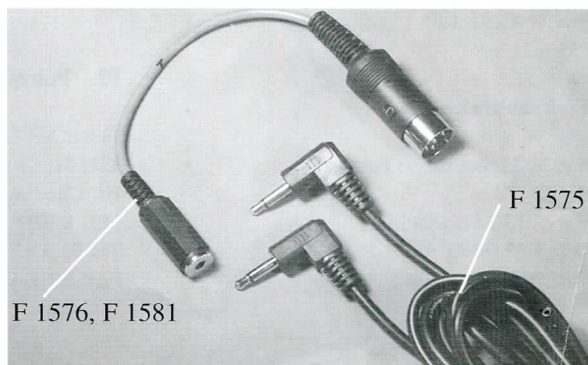

31: Trainer-und Adapterkabel